

Invited Review

Hydrogen Bonding: From Small Clusters to Biopolymers

Peter Schuster* and **Peter Wolschann**

Institut für Theoretische Chemie und Molekulare Strukturbiologie, Universität Wien, A-1090 Wien, Austria

Summary. High quality *ab initio* computations and molecular spectroscopy of small hydrogen-bonded clusters in the vapor phase provide highly accurate data in general agreement with the theory of hydrogen bonds developed in the seventies. Hydrogen bonding is a major force determining energetics and structures of biopolymers. In addition to direct influence through their directionality, hydrogen bonds set the stage for the formation of biopolymer structures indirectly since they determine the water structure. On the basis of current results hydrophobic interactions are considered equally important or even more relevant than direct hydrogen bonding. A new concept for protein and nucleic acid folding which is based on statistical mechanics allows to study the role of hydrogen bond formation in the nucleation process as well as in later states.

Keywords. Cluster; Hydrogen bond; Protein; Nucleic acid; Template.

Wasserstoffbrücken: Von kleinen Clustern zu Biopolymeren

Zusammenfassung. *Ab initio*-Rechnungen von hoher Qualität und die Gasphasenmolekülspektroskopie von kleinen Komplexen mit Wasserstoffbrücken liefern Daten von höchster Genauigkeit, welche in guter Übereinstimmung mit der in den Siebzigerjahren entwickelten Theorie der Wasserstoffbrückenbindung stehen. Wasserstoffbrücken bilden eines der wichtigsten energetischen und stereochemischen Prinzipien, welche die Strukturen der Biopolymeren bestimmen. Zusätzlich zum direkten Einfluß über ihre direktive Wirkung beeinflussen Wasserstoffbrücken aber auch indirekt die Ausbildung von Biopolymerstrukturen, da sie essentiell an der Struktur des flüssigen Wassers mitwirken. Die gegenwärtig zur Verfügung stehenden Daten legen nahe, daß die hydrophobe Wechselwirkung zumindest ebenso wichtig wenn nicht sogar noch wesentlicher ist als die direkten Wasserstoffbrücken. Ein neues Konzept zur Beschreibung der Faltung von Proteinen und Nukleinsäuren auf der Basis der statistischen Mechanik ermöglicht es, die Rolle der Ausbildung von Wasserstoffbrücken auch bei der Nukleation der Faltung und in späteren Phasen des Prozesses zu untersuchen.

* Corresponding author

1. Introduction

The molecular structures of the two most important classes of biopolymers, proteins and nucleic acids, are largely determined by hydrogen bonds: directly since they are important elements of biopolymer structure, and indirectly through hydrophobic interactions. Historically, the dominant role of hydrogen bonding became apparent in the early fifties through a few publications of model structures for proteins [1] and nucleic acids [2], respectively. The structures of both classes of biopolymers, *i.e.* α -helix and β -sheet of polypeptides and double helices of polynucleotides, are evidently built around the directions defined by optimal hydrogen bond geometry. Today, almost half a century after these milestone discoveries that initiated molecular biology, the understanding of biomolecular structures has become more subtle. The major driving force in structure formation of biopolymers appears to be hydrophobic interaction rather than hydrogen bonding. Helical structures of polypeptides are also formed when there is no possibility to form hydrogen bonds like, for example, in polyproline. Free energies of double helix formation are, in essence, determined by base pair stacking, and hydrogen bonding contributes only very little if at all. Specific template action is no privilege of hydrogen-bonded base pairs between nucleotides; it is found also in protein-protein interactions of the leucine zipper and has recently been used in the design of oligopeptides which are suitable for autocatalytic synthesis previously known only to occur with oligonucleotides [3]. Recent studies on natural ligand- and drug-receptor complexes [4] revealed that the importance of hydrophobic interactions has been underestimated so far, and the poor predictive power of rational design might well be a result of too much weight given to electrostatic forces, in particular to hydrogen bonding.

In essence, hydrogen bonds ($X-H \cdots Y$) differ from other intermolecular interactions in one aspect that makes them unique: only hydrogen atoms have no inner shell electrons, thus allowing for larger changes in electron densities than in other cases. The approach of a polar group towards a polar $X-H$ bond causes strong polarization effects that give rise to well known regularities in molecular structures and spectra which are commonly used as diagnostic tools for the detection of hydrogen bonds. Hydrogen bonds, in general, are not stronger than other intermolecular forces between polar groups or molecules, but their directive power is more pronounced. In other words, the strength of the interaction depends strongly on the relative orientations of the bond $X-H$ and the lone pair at the atom Y because of the local nature of the dipoles involved in a hydrogen bond. The preferred geometrical arrangement of the three atoms forming the hydrogen bond, *i.e.* X , H , and Y , is linear. The directionality of hydrogen bonds provides their major contribution to biopolymer structures: the (almost) linear hydrogen bond geometry is the basis for the structures of α - and other helices, β -pleated sheets, and nucleic acid base pairs.

During the last decade several books have been published on hydrogen bonding [5–8] as well as on hydrogen bonds within the broader aspects of molecular interactions [9] and molecular clusters [10]. In this overview we summarize current data on hydrogen bonding and try to describe the actual picture of structure formation and stability in biopolymers. Section 2 deals with the highly accurate results obtained by spectroscopy and *ab initio* calculations. In section 3 we shall briefly

report on the area of hydrogen-bonded networks in molecular clusters, a field which is very actively studied at present. The following three sections contain a state of the art review on the knowledge of biopolymer structures, stability, and formation as well as an outline of the current understanding of supramolecular complexes in biology. We end by giving an outlook to hydrogen bond research in biology.

2. Small Hydrogen-Bonded Complexes

The basic features of small hydrogen-bonded complexes were known in essence already in the seventies [11]. During the last decade the only remarkable progress was achieved in accuracy in both computational and experimental studies. Progress in computations was caused by the enormous increase in capacities and speed of the hardware that is now available at relatively low costs. Previously developed methods in the computation of electron correlation, like the *Møller-Plesset* perturbation theory and coupled cluster techniques, have become standard now in calculations of small intermolecular complexes. Basis sets that are consistent in accuracy with the correlation techniques are in common use [12]. In the water monomer, for example, the differences between calculated and experimental bond length, bond angle, harmonic vibrational frequencies, and dipole moment are less than 2%. The most successful experimental techniques are molecular-beam based electric resonance and infrared laser spectroscopy [13], which provide previously inaccessible insights into structures and dynamics of small complexes in the vapor phase.

In order to provide a representative example for the current state of the art we present a comparison of recent data for the water dimer (Fig. 1) in the vapor phase

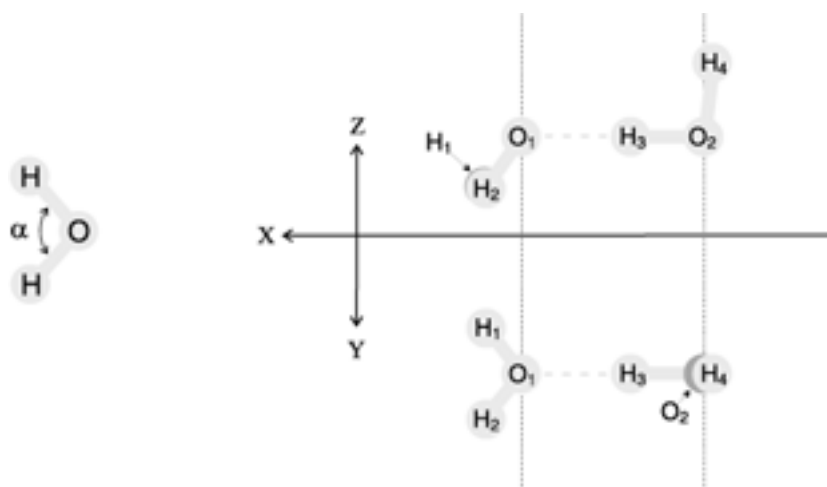

Fig. 1. Molecular geometry of the water dimer. The horizontal and vertical projection of the dimer is shown in C_s -geometry (which is frequently assumed in *ab initio* calculations); the (x,z) -plane is the plane of symmetry, $H_1H_2O_1$ is the acceptor, and $H_3H_4O_2$ the (hydrogen) donor molecule. Relative orientations of the two water molecules are described by rotations around an x -, y -, and z -axis through each of the two oxygen atoms. The *Eulerian* angles, χ , θ , and ϕ , are defined as angles between the C_2 -axis of water and the corresponding coordinate axis, y , z or x , respectively. The definition of the angle α in the free water molecule is shown at the left

Table 1. The hydrogen bond in the water dimer [14]. The geometry of the complex is shown in Fig. 1; values in parentheses refer to the isolated water monomer; the subscripts 0 and e refer to the vibrational ground state and the energy minimum of the dimer; 1 denotes the hydrogen acceptor and 2 the hydrogen donor molecule, and θ, ϕ , and χ are the *Eulerian* angles, respectively.

Quantity	Calculated value	Experimental value
$R_0(\text{O}_1\text{--O}_2)/\text{\AA}$	–	2.976
$R_e(\text{O}_1\text{--O}_2)/\text{\AA}$	2.898	2.946
$R_e(\text{O}_1\text{--H}_1)/\text{\AA}$	0.960 (0.959)	–(0.957)
$R_e(\text{O}_2\text{--H}_3)/\text{\AA}$	0.965 (0.959)	–(0.957)
$R_e(\text{O}_2\text{--H}_4)/\text{\AA}$	0.958 (0.959)	–(0.957)
$\alpha(\text{H}_1\text{--O}_1\text{--H}_2)/^\circ$	104.7 (104.3)	–(104.5)
$\alpha(\text{H}_3\text{--O}_2\text{--H}_4)/^\circ$	104.4 (104.3)	–(104.5)
$\theta_1/^\circ$	49.0	57 ± 10
$\theta_2/^\circ$	–52.2	-51 ± 10
$\phi_1/^\circ$	–	22 ± 8
$\chi_1/^\circ$	–	6 ± 20
$\chi_2/^\circ$	–	< 30
$D_e/\text{kJ} \cdot \text{mol}^{-1}$	–23.32	-22.6 ± 2.9
$D_0/\text{kJ} \cdot \text{mol}^{-1}$	–14.38	-15.1 ± 2.9

[14, 15] in Table 1. In addition to the molecular geometry and the dissociation energy of the complex, vibration frequencies were also calculated. Both the equilibrium dissociation energy and the zero point contribution from vibrations agree well with the experimental data: errors are in the range of one kJ/mol or less. The shift in the harmonic bond stretching frequency caused by the hydrogen bond is computed to be -171 cm^{-1} and is almost identical with data from matrix isolation (-169 cm^{-1}). Despite the already respectable accuracy achieved, the race for still higher precision is going on: new computational studies are dealing with improved accuracy in calculations of electronic properties [16, 17] and compete with results from near-infrared laser spectroscopy [18]. Recent studies on nuclear motion [19] gave evidence, nevertheless, on insufficient accuracy of energy surfaces for the excited states. The full spectroscopic information on the water dimer has also been used to derive a pair potential function that takes into account polarization of the water molecule [20].

A considerable number of other hydrogen-bonded homo- and heterodimers has been studied in the vapor phase, some of them with an accuracy comparable to that achieved for the water dimer. As examples we mention recent investigations of methanol clusters by infrared cavity ringdown spectroscopy [21] and a review including also clusters of hydrazine [22].

3. Nonadditivity, Clusters, and Hydrogen-Bonded Networks

Two classes of cooperative phenomena resulting in deviations from additivity of free energies are observed with hydrogen bonds coupled to polarizable electron systems: (i) resonance assisted hydrogen bonding and (ii) chains, cycles, or other networks of hydrogen bonds. In both cases hydrogen bonds become stronger as a

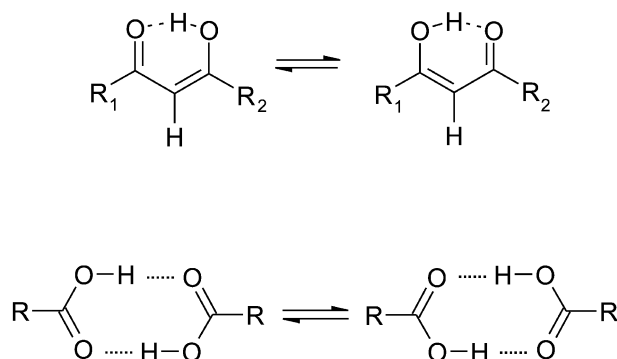

Fig. 2. Conjugation assisted hydrogen bonds. Two examples are shown: (i) the intramolecular hydrogen bond in the enol-form of an 1,3-dicarbonyl compound, and (ii) the two intermolecular hydrogen bonds in a carboxylic acid dimers. In both cases, the hydrogen bond is reinforced and proton transfer is facilitated by π -electron conjugation

result of coupling to the molecular environment. In other words, mutual polarization increases the strength of the hydrogen bond.

The first case is typical for intermolecular hydrogen bonds or hydrogen bonds in dimers where donor and acceptor are connected by one or more bonds with mobile, *i.e.* easily polarizable, electrons. These are commonly one or more conjugated π -electron bonds. The reinforcement of hydrogen bonds through cyclic conjugation is often characterized as resonance assisted hydrogen bonding. Representative examples are the hydrogen bonds in the enol-forms of 1,3-dicarbonyl compounds or the cyclic dimers of carboxylic acids (Fig. 2). Some cases are discussed in the contributions by *Koll* and *Wolschann* as well as by *Wolf et al.* in this issue (see also Ref. [23]). Other examples for resonance of coupled hydrogen bonds are the base pairs of nucleic acids in various geometrical arrangements [5]. They will also be mentioned in sections 4 and 5. Proton transfer along cycles of hydrogen bonds is facilitated when it is coupled to long-range displacements in electron distributions. Examples are proton transfer in the frequently studied dimers of carboxylic acids, water mediated proton transfer in formamide [24], and proton transfer in malonaldehyde [23].

The structures of molecular clusters provide not only information on the nature of the forces which shape these stable complexes of several molecules; they are also the most important tools for understanding and modelling of pure liquids and solutions. Both experimentalists and theorists have treated molecular clusters as a bridge between the gas phase and condensed matter. A survey consisting of a series of reviews on various clusters has been published recently [10]. Clusters in which hydrogen bonding determines structures and intermolecular energies of the aggregates are of particular interest since hydrogen-bonded liquids and protic solutions show features that are completely missing in *van der Waals* clusters or aprotic solvents. The behaviour of hydrogen-bonded clusters is dominated by the features of the hydrogen bond and reflects therefore also the influence of the involved molecules on the hydrogen bond strength and the related energetic properties. The importance of these hydrogen-bonded systems is clearly documented by the huge amount of investigations and publications on this topic. Some extended reviews

appeared just recently, collecting the experimental and theoretical studies of the last years [5, 9, 25–28]. These studies focus on the structures and the thermodynamic properties of the association complexes in order to provide a basis for understanding cooperativity in hydrogen-bonded networks, structural rearrangements, and proton transfer dynamics. Cooperative phenomena in hydrogen-bonded chains and networks result from mutual polarization between hydrogen bonds. Unusual strength of polarization and easy displacement of protons are consequences of the already mentioned peculiarity of the hydrogen atom resulting from the absence of inner shell electrons. Larger water clusters and their vibrational spectra have been predicted by *ab initio* calculations [14, 29] and compared to experiments [30–34]. A significant contraction of the OO-distance with increasing cluster size has been observed. The dynamics of linear water chains has been studied recently by *ab initio* molecular dynamics [35]. Diffusion dynamics and tunnelling in vibration-rotation spectra have also been considered recently [27, 28, 36–38].

Cyclic conformations of hydrogen-bonded chains are of particular interest since they show increased hydrogen bond strength and are assumed to exist in liquid water [14, 29]. Changes in the geometry of hydrogen-bonded networks are often considered in explanations for the peculiar properties of water like the increase of density between 0° and 4°C or the high mobility of protons and hydroxyl ions. Large clusters of up to 35 water molecules have been studied by less accurate computational methods [39]. These investigations try to find answers to questions how clustering influences the properties of individual molecules and whether or not the obtained results are suitable for extrapolations to large or infinite ensembles.

Studies on methanol clusters gave results similar to those obtained for water clusters: aggregates up to the size of four molecules exist in mainly cyclic conformation. This was shown by *ab initio* as well as by density functional methods [40–42] and experimentally verified by infrared cavity ringdown spectroscopy [21] as well as by vibrational spectroscopy [43, 44]. Pressure induced strengthening and temperature dependent weakening of hydrogen bonding in methanol clusters has been investigated by NMR spectroscopy [45]. Many extensive studies report on various association complexes of water and methanol molecules with other compounds from which we cite only a few examples: water and methanol with neutral molecules [46, 47], water with protons and other cations [47–49], and water with anions [12]. Finally and as a kind of curiosity, we mention a recent report on the formation of linear HCN chains in superfluid helium [50].

4. Hydrogen Bonds and Biopolymer Structures

The role of hydrogen bonding in biological structures was treated comprehensively in the monograph by *Jeffrey and Saenger* [5]. Here, we mention only some facts on the balance of hydrogen bonding within biopolymers and solvation of the molecules by water. Recent developments in the construction of supramolecular complexes provide new insights into the old problem of enthalpy-entropy compensation phenomena in aqueous solutions [51, 52].

The directive power of hydrogen bonds is apparently the major factor for the uniqueness and specificity of biopolymer structures. This commonly accepted fact creates a puzzle: biopolymers form their specific native structures only in aqueous

environments, but hydrogen bonding between acceptor and donor molecules is usually ineffective in aqueous solutions because of the excellent donor and acceptor properties of the water molecule [53]. Free energies of interaction reflect the differences in hydrogen bonding to the binding partner and the solvent, and they are commonly very small in aqueous solutions. In order to overcome this problem, chemists are constructing locally hydrophobic environments in order to exclude mobile water molecules [54, 55]. The hydrogen bond strength then becomes fully available, and highly specific and remarkably complex structures can be constructed. Obviously, hydrogen bonding and space filling are the two principles for the assembly of stable aggregations [56]. Another trick to improve hydrogen bonding is orientation of molecules on surfaces [53].

The same two principles, hydrogen bonding and space filling, are sufficient to explain the structures of biomolecules. The driving force for space filling is hydrophobic interaction that can be interpreted as a consequence of hydrogen bonding in the surrounding water. Proteins and nucleic acids form compact structures in water because of their tendency to minimize the area of the boundary to the solvent. Although there is no doubt concerning the nature of the forces stabilizing biopolymer conformations, the relative weights of the contributions are not yet known with sufficient accuracy. Hydrogen bonds define the specific geometry of secondary structures in proteins, in particular, in the α -helix and in other hydrogen-bonded helical conformations¹ or in the two different β -sheet conformations. Helix formation in polypeptides and proteins, on the other hand, is not dependent on hydrogen bonding. The two different polyproline helices (I and II) contain no hydrogen bonds since the nitrogen atom in the proline residue carries no hydrogen. Other examples are the various coiled coil structures built from α -helices. They are stabilized exclusively by the constraint of optimal packing as a result of hydrophobic forces.

Double helix formation in nucleic acids (*DNA* and *RNA*) is driven by base pair stacking and not by hydrogen bond formation. As mentioned before, the free energy contribution of hydrogen bonds to the base pairing energies in aqueous solutions is given by the difference in free energies between the hydrogen bonds in the complex and the hydrogen bonds to the solvent in the isolated molecules. Experiments performed in the seventies on double helix formation within one or between two *RNA* molecules [57] have shown indeed that the major contribution to the stability of double helical regions comes from base pair stacking rather than from hydrogen bond formation. These reactions can be described well by cooperative stack formation thermodynamics as expressed by Eq. (1) where K is the macroscopic equilibrium constant for stack formation, s is the microscopic constant for the conversion of a coil element into a segment of the double helix, σ is the nucleation parameter, and n is the length of the stack.

$$K(n) = \sigma \cdot s^n \quad (1)$$

Approximate values at $T=0^\circ\text{C}$ are $\sigma = 10^{-3}$, $s = 10$ for an **AU** and $s = 100$ for a **GC** pair. Accordingly, the formation of the first stable nucleus ($K(n) > 1$) requires four **AU** or two **GC** pairs, respectively.

¹ The best known examples are the 3.0_{10} - and the π -helix which, respectively, contain one amino acid less or one amino acid more than the α -helix between the $>\text{CO}$ and the $>\text{NH}$ group in the hydrogen-bonded loop.

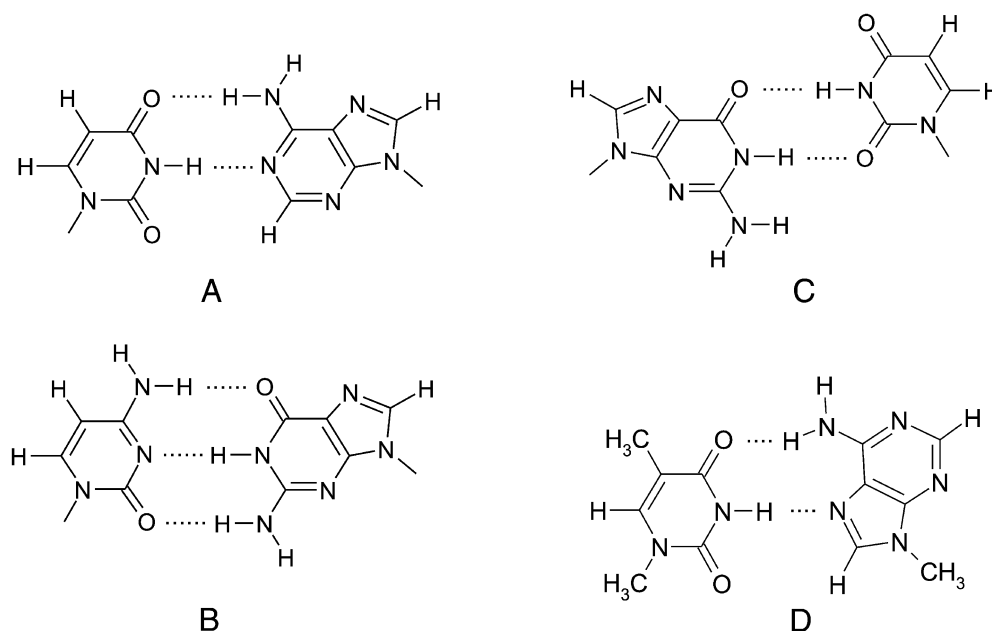

Fig. 3. Base pairing patterns of nucleotides. A and B represent the two *Watson-Crick* base pairs, **AU** and **GC**, respectively; the wobble pair **GU**, which occurs regularly in the A- and A'-conformation of *RNA*, is shown in C. D sketches a *Hoogsteen* pair between 1-methylthymine and 9-methyladenine. Gray circles indicate the positions at which the base pairs are connected to the ribose-phosphate backbone

Base pair stacking – unlike conventional hydrophobic interaction – is an enthalpy driven process. The driving force for stacking, however, is by no means less sophisticated than that for hydrophobic aggregation. The detailed molecular mechanism involves water structure in both cases: base or base pair stacking is not observed in non-aqueous media like, for example, chloroform. Stacking kinetics of nucleotide bases in absence of a ribose phosphate backbone has been studied by means of ultrasound absorption. These studies on N₂, N₉-dimethyladenine provide precise information on the thermodynamic parameters of nucleotide base stacking [58]. First encountered in the crystal structures of transfer-*RNAs*, end-to-end or coaxial stacking of double helical regions has been observed in most other structures determined so far, too [59, 60]. Extension of double helices in order to minimize contact areas between water and nucleotide bases seems to represent a general and highly relevant principle of *RNA* structure formation.

In addition to the long known conformations of base pairs, *i.e.* *Watson-Crick*, *Hoogsteen*, and wobble-**GU** (Fig. 3), a whole series of other hydrogen-bonded structures were found in the crystals and NMR spectra of *RNA* molecules. Double helices are often extended through a pair of purine bases (**AA**, **GA**, or **GG**) [60, 61]. Another hydrogen-bonded interaction, observed mainly in large interior loops, is the **UU** base pair [62–64]. These pyrimidine-pyrimidine pairs occur also in small clusters, *e.g.* (**UU**)_{*n*} with *n* = 2, 3. Base interactions are not confined to pairs; base triples (Fig. 4) occur regularly, and several examples are already known from crystal structures of transfer-*RNAs*. Quartets of **Gs** and **A** platforms [60] represent

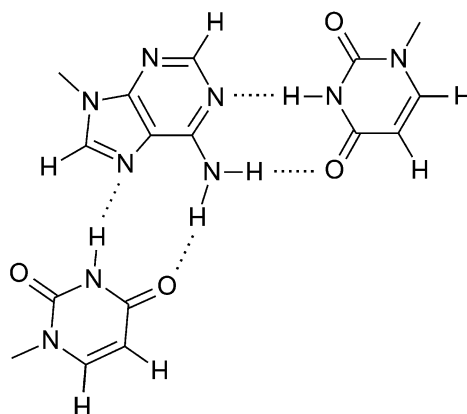

Fig. 4. Conformation of the uracil-adenine-uracil trimer. The trimer represents a combination of a *Watson-Crick* and a *Hoogsteen* base pair. It can be readily incorporated into a triple helix as it is found in the poly-A.(poly-U)₂ aggregate

examples of interactions between four bases with regular structures. In this context we mention also an extensive *ab initio* study on hydrogen bonding and stacking of nucleic acid bases and base pairs which was undertaken in order to derive potentials of mean force for nucleotide bases [65]. Contributions of the aqueous medium were taken into account by means of a *Langevin* dipole solvation model.

Template action is the basis of nucleic acid replication and thus fundamental to biology. *DNA* and *RNA* replication is based on the complementarity of the bases in *Watson-Crick* base pairs (Fig. 3). Hence, template action is determined by hydrogen bonding, and it was indeed possible to synthesize self-complementary oligonucleotides through the autocatalytic reaction shown in Fig. 5 without the help of enzymes [66]. All other chemical systems showing template action made use of hydrogen bonding in suitable molecular environments. Recently, template action was extended to oligopeptides [3]. In this example, complementarity is not based on patterns of hydrogen bonds but on space filling (Fig. 5). For two α -helices with complementary patterns of leucine and valine residues on their hydrophobic sides an autocatalytic replication process based on this “knobs into holes” – interaction has been designed and successfully realized.

The exploration of the structures of supramolecular complexes is one of the most remarkable successes of recent structural biology. Structures of cellular particles as complex as the ribosome will soon be available at atomic resolution [67]. The structures of several virus particles or so-called virions have been determined at sufficiently high resolution for the identification of their molecular geometry [68].

5. Folding of Biopolymers

The conventional view of protein folding was initiated by the results of experiments on the denaturation of small proteins performed in the sixties and early seventies [69, 70]. Several small protein molecules like ribonuclease S undergo reversible denaturation with a simple two step kinetics, $N \rightleftharpoons C$, showing

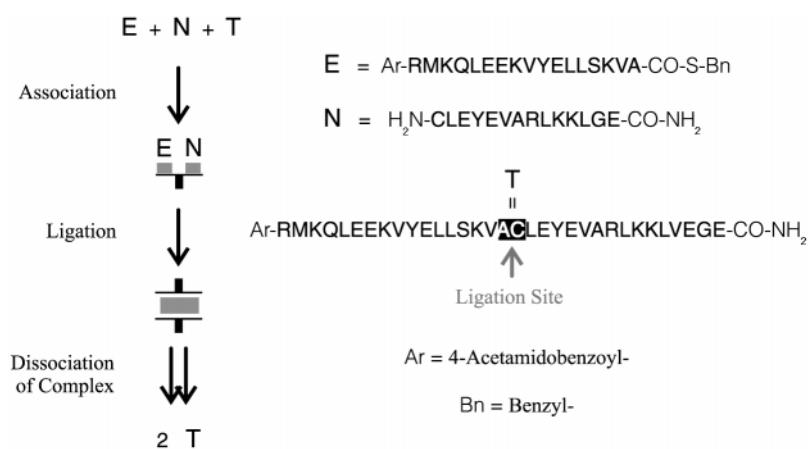

Autocatalytic Replication of an Oligopeptide

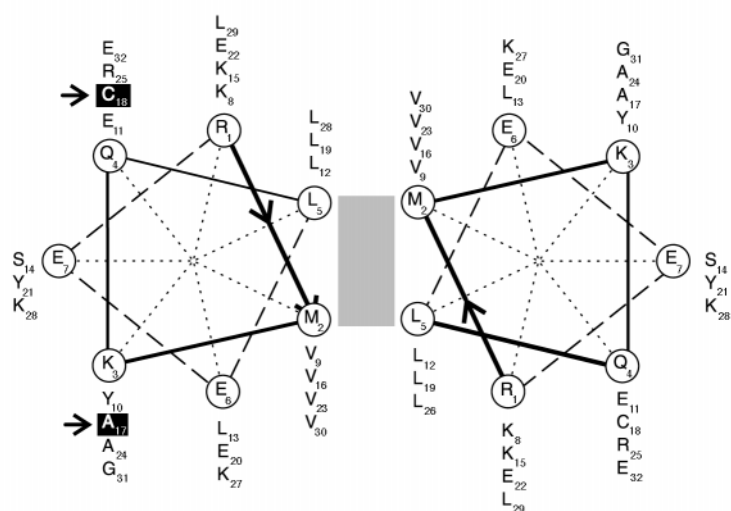

Helical-Wheel Diagram of Template-Ligand Interactions

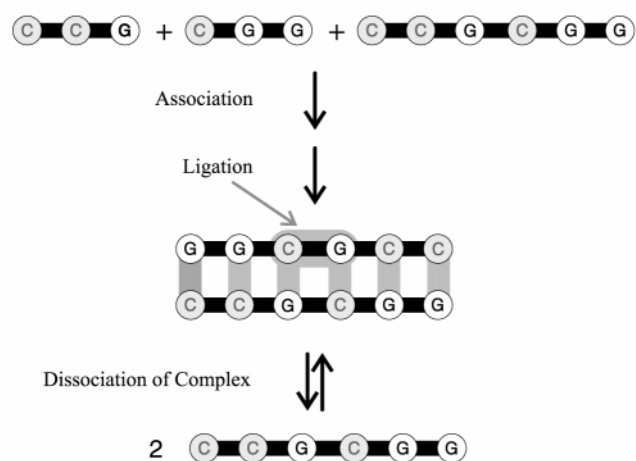

Autocatalytic Replication of a Hexanucleotide

that only the native state (N) and the random coil state (C) are significantly populated. Experimental studies on protein-ligand binding at low temperatures [71] revealed, however, that not only the populations in loose random coils but also in the rigid native states of proteins are highly heterogeneous. What has been

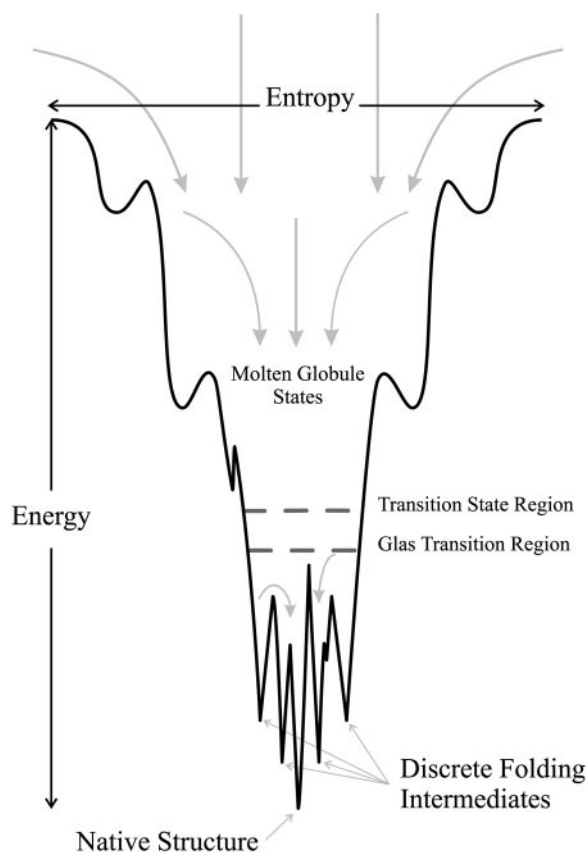

Fig. 6. Funneling trajectories of protein folding. Proteins have extremely large numbers of conformations and hence random coils would not be able to fold into the native states within reasonable times unless there are folding pathways guiding the molecules towards the energy minimum [72]. A statistical theory of protein conformations provides an explanation for the folding problem [73]: a very large number of initial random coil conformations gives rise to a smaller number of partially folded intermediate states which in turn form a still smaller number of compact states. The diversity of pathways leading towards the native state is reduced with decreasing energy, and eventually the molecule ends up in the native conformation



Fig. 5. Templates in molecular replication. Two examples of autocatalytic oligomer formation are shown. The upper part presents a reaction on an oligopeptide template where the aggregation is caused by hydrophobic forces [3]. Specificity of the interaction results from “knobs into holes” space filling of valine and leucine residues which appear on opposite sides on the two α -helices forming the coiled coil (see the **V** and **L** residues in the helical-wheel diagram). The lower part of the figure shows the template induced autocatalytic synthesis of the hexamer **CCGCGG** [66] from trimers. Template interaction of oligonucleotides results from conventional *Watson-Crick* type hydrogen bonding between **G** and **C**

considered as a single distinct conformation turned out as a family of structurally similar conformations, each corresponding to an individual local minimum of the conformational energy landscape. Conformational diversity is reduced during the folding process that eventually ends in the native state [72, 73]. This idea of a very large number of folding pathways merging into fewer and fewer trajectories during the approach to the thermodynamically most stable state has been characterized as the folding funnel paradigm (Fig. 6).

Folding of protein molecules starts through nucleation of secondary structure elements, commonly α -helices, and leads to an intermediate form that is already condensed but still shows a certain degree of mobility [74]. This intermediate has been characterized as molten globule and contains a high fraction of the hydrogen bonds found in the native structure. In case of single stranded *RNA* molecules folding is initiated by the formation of double helical regions or stacks making up the so-called secondary structure which is rigidified by the formation of tertiary contacts and presumably represents a folding intermediate as the molten globule does for protein folding.

6. Conclusions and Outlook

Investigations and computational studies on small molecular systems have reached a previously unimaginable accuracy. This holds in particular also for small intermolecular complexes including those involving hydrogen bonds. Errors as small as a few percent in molecular structures, energies, and vibrational frequencies have been achieved in recent calculations. The quality of computed data competes successfully with the results from experimental studies which are mainly based on molecular beam electric resonance and IR laser spectroscopy. For larger systems the achievable accuracy is less, but computations are still useful. Investigations on hydrogen-bonded clusters of many molecules are currently in progress and reveal more and more accurate data on large aggregates that show almost bulk-like properties in the interior. In the future these studies will eventually lead to a better understanding of associated liquids and protic solutions.

Despite impressive successes in the prediction of biopolymer structures the theory still suffers from insufficient or even inadequate treatment of the solvent. In molecular dynamics simulations of biopolymers a few thousand water molecules are added, but often this is even not enough for full coverage of the molecular surface. Further progress in the theory of hydrogen-bonded liquids, in particular water, will be of great help in the theory of biopolymer structures. The hydrophobic force which leads to condensation of proteins in water is a consequence of the peculiar properties of liquid water. The same is true for base pair stacking that provides the major force in the formation of nucleic acid structures.

Protein structures are the result of a delicate balance between hydration of polar groups at the surface and hydrophobic collapse of the residues buried in the interior. The current theory of protein folding is based on the statistical mechanics of this collapse. It allows to analyze and to understand the role of hydrogen bonding in the nucleation complexes as well as in later condensed states like the molten globule. *RNA* folding is less well understood than protein folding but shows striking similarities: the conventional hydrophobic force is replaced by the stacking

interaction of nucleotide bases and base pairs. Loose RNA conformations with fully developed secondary structures are, presumably, the counterparts of molten globules.

References

- [1] Pauling L, Corey RB, Branson HR (1951) *Proc Natl Acad Sci USA* **37**: 205; Pauling L, Corey RB (1951) *Proc Natl Acad Sci USA* **37**: 251 and 729
- [2] Watson J, Crick FHC (1953) *Nature* **171**: 737
- [3] Lee DH, Granja JR, Martinez JA, Severin K, Ghadiri R (1996) *Nature* **382**: 525
- [4] Davis AM, Teague SJ (1999) *Angew Chem Int Ed* **38**: 736
- [5] Jeffrey GA, Saenger W (1991) *Hydrogen Bonding in Biological Structures*. Springer, Berlin
- [6] Smith DA (ed) (1994) *Modeling the Hydrogen Bond*, vol 569. American Chemical Society, Washington, DC
- [7] Scheiner S (1997) *Hydrogen Bonding. A Theoretical Perspective*. Oxford University Press, NY
- [8] Jeffrey GA (1997) *An Introduction to Hydrogen Bonding*. Oxford University Press, NY
- [9] Scheiner S (ed) (1997) *Molecular Interactions. From van der Waals to Strongly Bond Complexes*. Wiley, Chichester, UK
- [10] Bowman JM, Bačić Z (eds) (1998) *Molecular Clusters. Advances in Molecular Vibrations and Collision Dynamics*, vol 3. JAI Press, Stamford, CT
- [11] Schuster P, Zundel G, Sándorfy C (1976) *The Hydrogen Bond – Recent Developments in Theory and Experiment*, vol I–III. North Holland, Amsterdam
- [12] Xantheas SS, Dunning TH Jr (1998) *Ab Initio* Characterization of Water and Anion-Water Clusters. In: Ref. [10], p. 281
- [13] Weber A (ed) (1987) *Structure and Dynamics of Weakly Bonded Molecular Complexes*. Reidel, Dordrecht
- [14] Xantheas SS, Dunning TH Jr (1993) *J Chem Phys* **99**: 8774
- [15] Mack KM, Muenter JS (1977) *J Chem Phys* **66**: 498
- [16] Tschumper GS, Kely MD, Schaefer III HF (1999) *Mol Phys* **96**: 493
- [17] Klopper W, Lüthi HP (1999) *Mol Phys* **96**: 559
- [18] Huang ZS, Miller RE (1997) *J Chem Phys* **91**: 6613
- [19] Leforestier C, Braly LB, Liu K, Elrod MJ, Saykally RJ (1997) *J Chem Phys* **106**: 8527
- [20] Fellers RS, Leforestier C, Braly LB, Brown MG, Saykally RJ (1999) *Science* **284**: 945
- [21] Provencal RA, Paul JB, Roth K, Chapo C, Casaes RN, Saykally JR, Tschumper GS, Schaefer III HF (1999) *J Chem Phys*. **110**: 4258
- [22] Buck U (1998) *Vibrational Spectroscopy of Small Size-Selected Clusters*. In: Ref. [10], pp 127–161
- [23] Wolf K, Mikenda W, Nusterer E, Schwarz K, Ulbricht C (1998) *Chem Eur J* **4**: 1418
- [24] Kim Y, Lim S, Kim H-J, Kim Y (1999) *J Chem Phys A* **103**: 617
- [25] Deakyne CA (1997) *Conventional and Unconventional Hydrogen-Bonded Ionic Clusters*. In: Ref. [9], p 217
- [26] Karpfen A (1997) *Case Studies in Cooperativity in Hydrogen-Bonded Clusters and Polymers*. In: Ref. [9], p 265
- [27] Gregory JK, Clary DC (1998) *Diffusion Monte Carlo Studies of Water Clusters*. In: Ref. [10], pp 311–364
- [28] Wales DJ (1998) *Rearrangements and Tunneling in Water Clusters*. In: Ref. [10], p 397
- [29] Klopper W, Schütz M (1995) *Ber Bunsenges Phys Chem* **99**: 469
- [30] Dykstra CE (1999) *Chem Phys Letters* **299**: 132
- [31] Graf S, Leutwyler S (1998) *J Chem Phys* **109**: 5393
- [32] Jongseob Kim, Kwang S Kim (1998) *J Chem Phys* **109**: 5886

- [33] Hartke B, Schütz M, Werner HJ (1998) Chem Phys **239**: 561
- [34] Kryachko E (1998) Int J Quant Chem **70**: 831
- [35] Mei HS, Tuckerman ME, Sagnella DE, Klein ML (1998) J Phys Chem B **102**: 10446
- [36] Sabo D, Bacic Z, Graf S, Leutwyler S (1998) J Chem Phys **109**: 5404
- [37] Brown MG, Keutsch FN, Saykally RJ (1998) J Chem Phys **109**: 9645
- [38] Liem X Dang (1999) J Chem Phys **110**: 1526
- [39] Khan A (1999) J Phys Chem A **103**: 1260
- [40] Buck U, Ettischer I (1998) J Chem Phys **108**: 33
- [41] Buck U, Siebers JG, Wheatley RJ (1998) J Chem Phys **108**: 20
- [42] Mo O, Yanez M, Elguero J (1997) J Chem Phys **107**: 3592
- [43] Hagemester FC, Gruenloh CJ, Zwier TS (1998) J Phys Chem A **102**: 82
- [44] Parra RD, Zeng XC (1999) J Chem Phys **110**: 6329
- [45] Czeslik C, Jonas J (1999) Chem Phys Letters **302**: 633
- [46] Zwier TS (1998) The Infrared Spectroscopy of Hydrogen-Bonded Clusters: Chains, Cycles, Cubes, and Three-Dimensional Networks. In: Ref. [10], p 249
- [47] Ebata T, Fujii A, Mikami N (1998) Int Rev Phys Chem **17**: 331
- [48] Marx D, Tuckerman ME, Hutter J, Parrinello M (1999) Nature **397**: 601
- [49] Brugé F, Bernasconi M, Parrinello M (1999) J Chem Phys **110**: 4734
- [50] Nauta K, Miller RE (1999) Science **283**: 1895
- [51] Lumry R, Rajender S (1970) Biopolymers **9**: 1125
- [52] Lauffer MA (1975) Entropy-Driven Processes in Biology. Polymerization of Tobacco Mosaic Virus Protein and Similar Reactions. Springer, Berlin
- [53] Ariga K, Kunitake T (1998) Acc Chem Res **31**: 371
- [54] Rotello VM, Viana EA, Deslongchamps G, Murray BA, Rebek J Jr (1993) J Am Chem Soc **115**: 797
- [55] Torneiro M, Still WC (1995) J Am Chem Soc **117**: 5887
- [56] Martin T, Obst U, Rebek J Jr (1998) Science **281**: 1842
- [57] Pörschke D (1977) Elementary Steps of Base Recognition and Helix-Coil Transitions in Nucleic Acids. In: Pecht I, Rigler R (eds) Chemical Relaxation in Molecular Biology. Springer, Berlin
- [58] Pörschke D, Eggers F (1972) Eur J Biochem **26**: 490
- [59] Pley HW, Flaherty KM, McKay D (1994) Nature **372**: 68
- [60] Cate JH, Gooding AR, Podell E, Zhou K, Golden BL, Kundrot CE, Cech TR, Doudna JA (1996) Science **273**: 1678
- [61] Huang S, Wang Y-X, Draper DE (1996) J Mol Biol **258**: 308
- [62] Baeyens KJ, De Bondt HL, Holbrook (1995) Nat Struct Biol **2**: 56
- [63] Wang Y-X, Huang S, Draper DE (1996) Nucleic Acids Res **24**: 2666
- [64] Lietzke SE, Barnes CL, Berglund JA, Kundrot CE (1996) Structure **4**: 917
- [65] Florián J, Šponer J, Warshel A (1999) J Phys Chem B **103**: 884
- [66] von Kiedrowski G (1986) Angew Chem Int Ed Engl **25**: 932
- [67] Green R, Noller HF (1997) Ann Rev Biochem **66**: 679
- [68] Wah C, Burnett RM, Garcea RL (1997) Structural Biology of Viruses. Oxford Univ Press, NY
- [69] Tanford C (1961) Physical Chemistry of Macromolecules. Wiley, New York
- [70] Anfinsen CB (1973) Science **181**: 223
- [71] Frauenfelder H, Parak F, Young RD (1988) Ann Rev Biophys Biophys Chem **17**: 451
- [72] Dill KA, Chan HS (1997) Nat Struct Biol **4**: 10
- [73] Bryngelson JD, Onuchic JN, Socci ND, Wolynes PG (1995) Proteins Struct Funct Gen **21**: 167
- [74] Freire E (1995) Ann Rev Biophys Biomol Struct **24**: 141

Received May 3, 1999. Accepted May 4, 1999